

# NTGD3148N

## Power MOSFET

### 20 V, 3.5 A, Dual N-Channel, TSOP-6



**ON Semiconductor®**

<http://onsemi.com>

#### Features

- Low Threshold Levels,  $V_{GS(th)} < 1.5$  V
- Low Gate Charge (3.8 nC)
- Leading Edge Trench Technology of Low  $R_{DS(on)}$
- High Power and Current Handling Capability
- This is a Pb-Free Device

#### Applications

- DC-DC Converters (Buck and Boost Circuits)
- Low Side Load Switch
- Optimized for Battery and Load Management Applications in Portable Equipment Like Cell Phones, DSCs, Media Player, Etc
- Battery Charging and Protection Circuits

#### N-CHANNEL MOSFET

$V_{(BR)DSS}$	$R_{DS(on)}$ Max	$I_D$ Max
20 V	70 mΩ @ 4.5 V	3.5 A
	100 mΩ @ 2.5 V	

#### MAXIMUM RATINGS ( $T_J = 25^\circ\text{C}$ unless otherwise noted)

Parameter			Symbol	Value	Unit
Drain-to-Source Voltage			$V_{DSS}$	20	V
Gate-to-Source Voltage			$V_{GS}$	$\pm 12$	V
Continuous Drain Current (Note 1)	Steady State	$T_A = 25^\circ\text{C}$	$I_D$	3.0	A
		$T_A = 85^\circ\text{C}$		2.2	
Continuous Drain Current (Note 1)	$t \leq 5$ s	$T_A = 25^\circ\text{C}$	$I_D$	3.5	A
Power Dissipation (Note 1)	Steady State	$T_A = 25^\circ\text{C}$	$P_D$	0.9	W
	$t \leq 5$ s			1.1	
Pulsed Drain Current		$t_p = 10$ μs	$I_{DM}$	10	A
Operating Junction and Storage Temperature			$T_J, T_{STG}$	-50 to 150	$^\circ\text{C}$
Source Current (Body Diode)			$I_S$	0.8	A
Lead Temperature for Soldering Purposes (1/8" from case for 10 s)			$T_L$	260	$^\circ\text{C}$

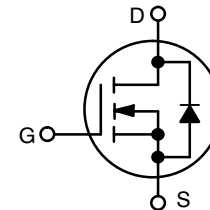

N-CHANNEL MOSFET



1  
TSOP-6  
CASE 318G  
STYLE 13

#### MARKING DIAGRAM

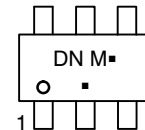

DN = Specific Device Code  
M = Date Code  
▪ = Pb-Free Package  
(Note: Microdot may be in either location)

#### THERMAL RESISTANCE RATINGS

Parameter	Symbol	Value	Unit
Junction-to-Ambient — Steady State (Note 1)	$R_{\theta JA}$	140	$^\circ\text{C}/\text{W}$
Junction-to-Ambient — $t \leq 5$ s (Note 1)	$R_{\theta JA}$	110	$^\circ\text{C}/\text{W}$

Stresses exceeding Maximum Ratings may damage the device. Maximum Ratings are stress ratings only. Functional operation above the Recommended Operating Conditions is not implied. Extended exposure to stresses above the Recommended Operating Conditions may affect device reliability.

1. Surface Mounted on FR4 Board using 1 in sq pad size (Cu area = 1.127 in sq [1 oz] including traces).

#### PIN CONNECTION

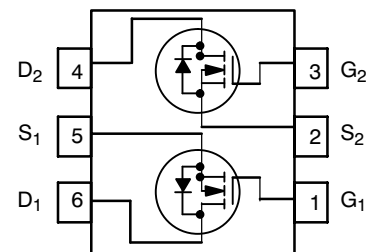

(Top View)

#### ORDERING INFORMATION

See detailed ordering and shipping information in the package dimensions section on page 2 of this data sheet.

# NTGD3148N

## MOSFET ELECTRICAL CHARACTERISTICS (T<sub>J</sub> = 25°C unless otherwise noted)

Characteristic	Symbol	Test Condition	Min	Typ	Max	Unit
----------------	--------	----------------	-----	-----	-----	------

### OFF CHARACTERISTICS

Drain-to-Source Breakdown Voltage	V <sub>(BR)DSS</sub>	V <sub>GS</sub> = 0 V, I <sub>D</sub> = 250 μA	20			V
Drain-to-Source Breakdown Voltage Temperature Coefficient	V <sub>(BR)DSS</sub> /T <sub>J</sub>	I <sub>D</sub> = 250 μA, Ref to 25°C		12.5		mV/°C
Zero Gate Voltage Drain Current	I <sub>DSS</sub>	V <sub>GS</sub> = 0 V, V <sub>DS</sub> = 16 V	T <sub>J</sub> = 25°C		1.0	μA
			T <sub>J</sub> = 125°C		10	
Gate-to-Source Leakage Current	I <sub>GSS</sub>	V <sub>DS</sub> = 0 V, V <sub>GS</sub> = ±12 V			100	nA

### ON CHARACTERISTICS (Note 2)

Gate Threshold Voltage	V <sub>GS(TH)</sub>	V <sub>GS</sub> = V <sub>DS</sub> , I <sub>D</sub> = 250 μA	0.5		1.5	V
Gate Threshold Temperature Coefficient	V <sub>GS(TH)</sub> /T <sub>J</sub>			3.28		mV/°C
Drain-to-Source On Resistance	R <sub>DS(on)</sub>	V <sub>GS</sub> = 4.5 V, I <sub>D</sub> = 3.5 A		41.7	70	mΩ
		V <sub>GS</sub> = 2.5 V, I <sub>D</sub> = 2.8 A		58	100	
Forward Transconductance	g <sub>FS</sub>	V <sub>DS</sub> = 5.0 V, I <sub>D</sub> = 3.5 A		6.2		S

### CHARGES, CAPACITANCES AND GATE RESISTANCE

Input Capacitance	C <sub>ISS</sub>	V <sub>GS</sub> = 0 V, f = 1.0 MHz, V <sub>DS</sub> = 10 V		300		pF
Output Capacitance	C <sub>OSS</sub>			73		
Reverse Transfer Capacitance	C <sub>RSS</sub>			44		
Total Gate Charge	Q <sub>G(TOT)</sub>	V <sub>GS</sub> = 4.5 V, V <sub>DS</sub> = 10 V, I <sub>D</sub> = 3.5 A		3.8		nC
Threshold Gate Charge	Q <sub>G(TH)</sub>			0.3		
Gate-to-Source Charge	Q <sub>GS</sub>			0.7		
Gate-to-Drain Charge	Q <sub>GD</sub>			1.1		
Gate Resistance	R <sub>G</sub>			2.8		Ω

### SWITCHING CHARACTERISTICS (Note 3)

Turn-On Delay Time	t <sub>d(ON)</sub>	V <sub>GS</sub> = 4.5 V, V <sub>DS</sub> = 10 V, I <sub>D</sub> = 3.5 A, R <sub>G</sub> = 3.0 Ω		7.4		ns
Rise Time	t <sub>r</sub>			11.2		
Turn-Off Delay Time	t <sub>d(OFF)</sub>			12.8		
Fall Time	t <sub>f</sub>			1.6		

### DRAIN-TO-SOURCE CHARACTERISTICS

Forward Diode Voltage	V <sub>SD</sub>	V <sub>GS</sub> = 0 V, I <sub>D</sub> = 0.8 A	T <sub>J</sub> = 25°C		0.71	V
			T <sub>J</sub> = 125°C		0.57	
Reverse Recovery Time	t <sub>RR</sub>	V <sub>GS</sub> = 0 V, d <sub>IS</sub> /d <sub>t</sub> = 100 A/μs, I <sub>S</sub> = 0.8 A		9.0		ns
Charge Time	T <sub>a</sub>			5.0		
Discharge Time	T <sub>b</sub>			4.0		
Reverse Recovery Time	Q <sub>RR</sub>			2.5		nC

2. Pulse Test: pulse width ≤ 300 μs, duty cycle ≤ 2%.

3. Switching characteristics are independent of operating junction temperatures.

### ORDERING INFORMATION

Device	Package	Shipping†
NTGD3148NT1G	TSOP-6 (Pb-Free)	3000 / Tape & Reel

†For information on tape and reel specifications, including part orientation and tape sizes, please refer to our Tape and Reel Packaging Specifications Brochure, BRD8011/D.

# NTGD3148N

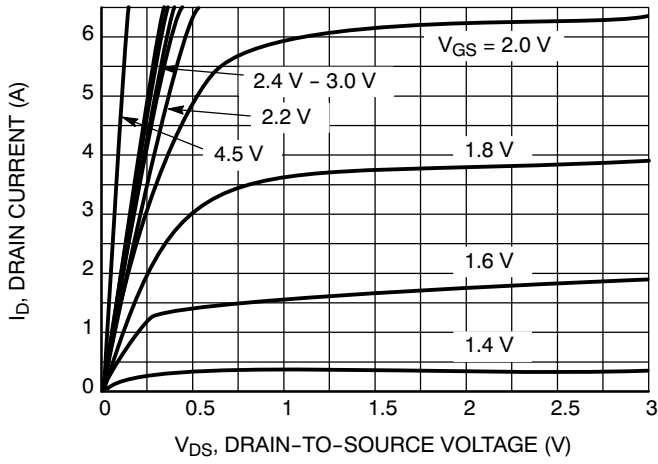

**Figure 1. On-Region Characteristics**

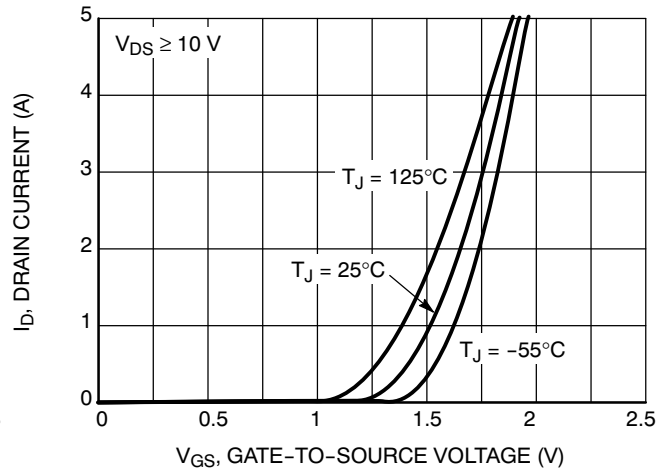

**Figure 2. Transfer Characteristics**

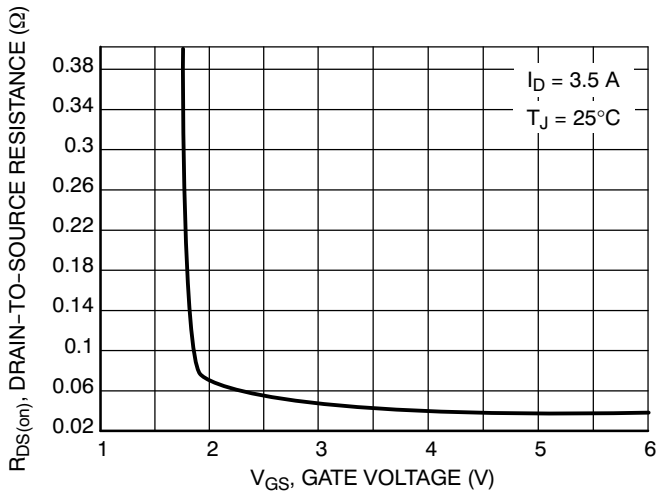

**Figure 3. On-Resistance vs. Voltage**

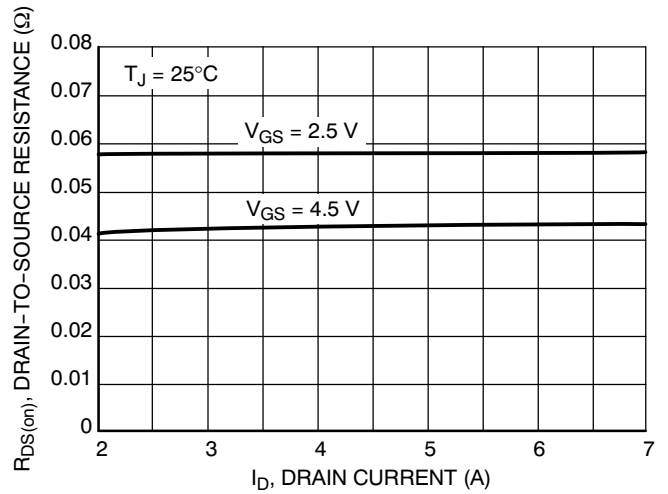

**Figure 4. On-Resistance vs. Drain Current and Gate Voltage**

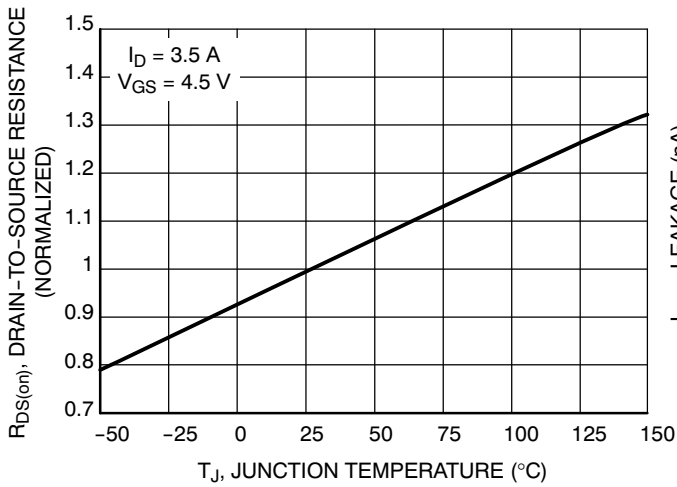

**Figure 5. On-Resistance Variation vs. Temperature**

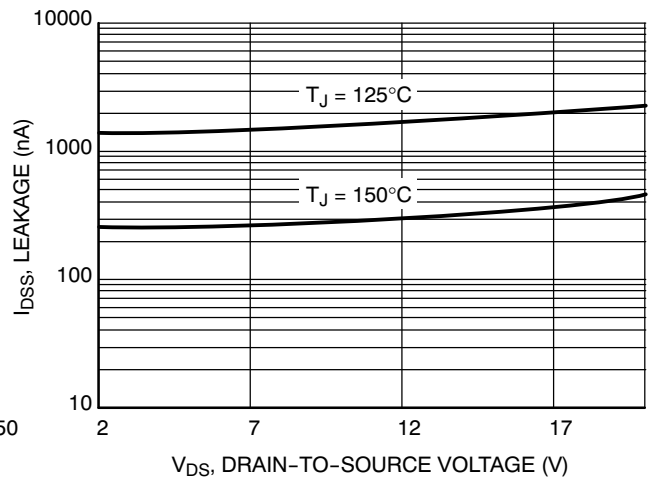

**Figure 6. Drain-to-Source Leakage Current vs. Voltage**

# NTGD3148N

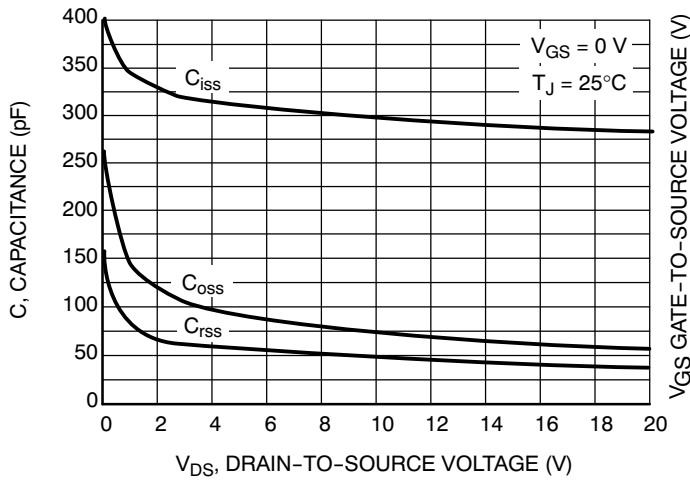

Figure 7. Capacitance Variation

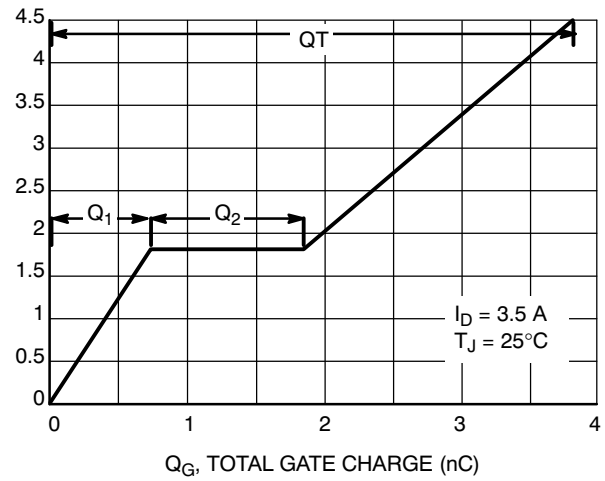

Figure 8. Gate-To-Source and Drain-To-Source Voltage vs. Total Charge

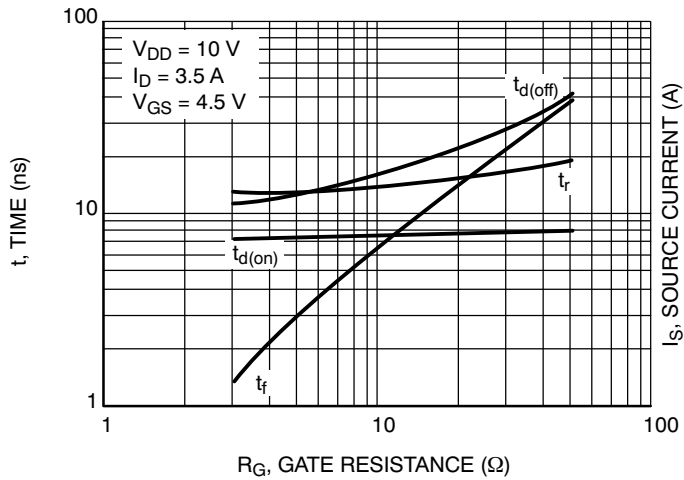

Figure 9. Resistive Switching Time Variation vs. Gate Resistance

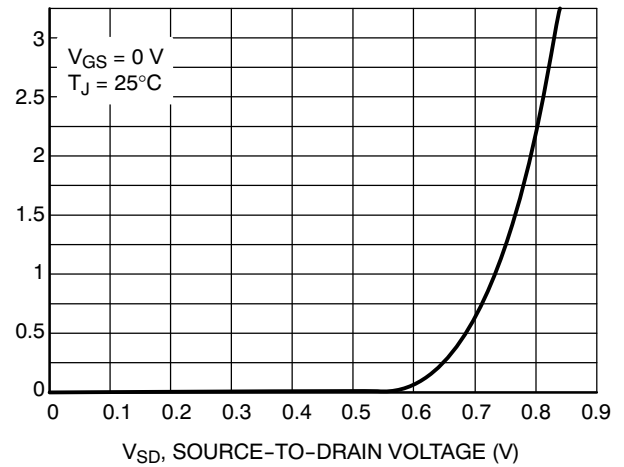
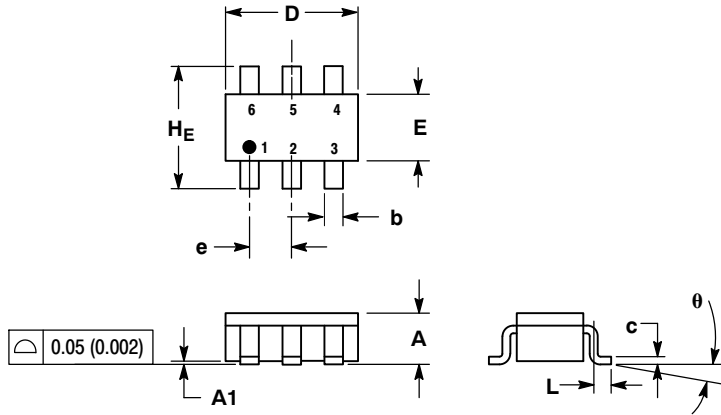

Figure 10. Diode Forward Voltage vs. Current

# NTGD3148N

## PACKAGE DIMENSIONS

TSOP-6  
CASE 318G-02  
ISSUE S



**NOTES:**

1. DIMENSIONING AND TOLERANCING PER ANSI Y14.5M, 1982.
2. CONTROLLING DIMENSION: MILLIMETER.
3. MAXIMUM LEAD THICKNESS INCLUDES LEAD FINISH THICKNESS. MINIMUM LEAD THICKNESS IS THE MINIMUM THICKNESS OF BASE MATERIAL.
4. DIMENSIONS A AND B DO NOT INCLUDE MOLD FLASH, PROTRUSIONS, OR GATE BURRS.

DIM	MILLIMETERS			INCHES		
	MIN	NOM	MAX	MIN	NOM	MAX
A	0.90	1.00	1.10	0.035	0.039	0.043
A1	0.01	0.06	0.10	0.001	0.002	0.004
b	0.25	0.38	0.50	0.010	0.014	0.020
c	0.10	0.18	0.26	0.004	0.007	0.010
D	2.90	3.00	3.10	0.114	0.118	0.122
E	1.30	1.50	1.70	0.051	0.059	0.067
e	0.85	0.95	1.05	0.034	0.037	0.041
L	0.20	0.40	0.60	0.008	0.016	0.024
HE	2.50	2.75	3.00	0.099	0.108	0.118
θ	0°	-	10°	0°	-	10°

**STYLE 13:**

- PIN 1. GATE 1
- SOURCE 2
- GATE 2
- DRAIN 2
- SOURCE 1
- DRAIN 1

### SOLDERING FOOTPRINT\*

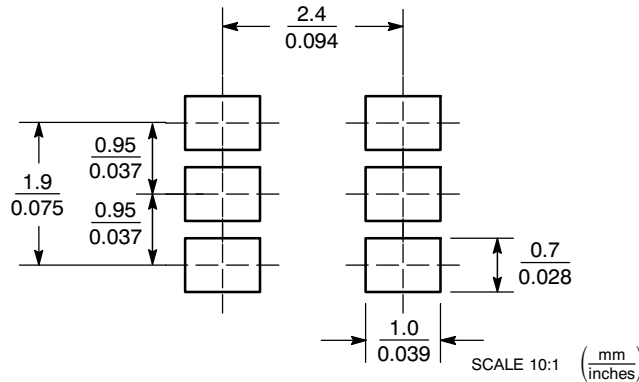

\*For additional information on our Pb-Free strategy and soldering details, please download the ON Semiconductor Soldering and Mounting Techniques Reference Manual, SOLDERRM/D.

ON Semiconductor and are registered trademarks of Semiconductor Components Industries, LLC (SCILLC). SCILLC reserves the right to make changes without further notice to any products herein. SCILLC makes no warranty, representation or guarantee regarding the suitability of its products for any particular purpose, nor does SCILLC assume any liability arising out of the application or use of any product or circuit, and specifically disclaims any and all liability, including without limitation special, consequential or incidental damages. "Typical" parameters which may be provided in SCILLC data sheets and/or specifications can and do vary in different applications and actual performance may vary over time. All operating parameters, including "Typicals" must be validated for each customer application by customer's technical experts. SCILLC does not convey any license under its patent rights nor the rights of others. SCILLC products are not designed, intended, or authorized for use as components in systems intended for surgical implant into the body, or other applications intended to support or sustain life, or for any other application in which the failure of the SCILLC product could create a situation where personal injury or death may occur. Should Buyer purchase or use SCILLC products for any such unintended or unauthorized application, Buyer shall indemnify and hold SCILLC and its officers, employees, subsidiaries, affiliates, and distributors harmless against all claims, costs, damages, and expenses, and reasonable attorney fees arising out of, directly or indirectly, any claim of personal injury or death associated with such unintended or unauthorized use, even if such claim alleges that SCILLC was negligent regarding the design or manufacture of the part. SCILLC is an Equal Opportunity/Affirmative Action Employer. This literature is subject to all applicable copyright laws and is not for resale in any manner.

### PUBLICATION ORDERING INFORMATION

**LITERATURE FULFILLMENT:**  
Literature Distribution Center for ON Semiconductor  
P.O. Box 61312, Phoenix, Arizona 85082-1312 USA  
**Phone:** 480-829-7710 or 800-344-3860 Toll Free USA/Canada  
**Fax:** 480-829-7709 or 800-344-3867 Toll Free USA/Canada  
**Email:** orderlit@onsemi.com

**N. American Technical Support:** 800-282-9855 Toll Free USA/Canada  
**Japan:** ON Semiconductor, Japan Customer Focus Center  
2-9-1 Kamimeguro, Meguro-ku, Tokyo, Japan 153-0051  
**Phone:** 81-3-5773-3850

**ON Semiconductor Website:** <http://onsemi.com>  
**Order Literature:** <http://www.onsemi.com/litorder>

For additional information, please contact your local Sales Representative.